

# ANH-BB-F1

## QUICK CLOSING VALVE (F7399-5K-L-BRZ)

Valveco®

angle pattern, pneumatic / manual operator, bronze body and trim, 5k, flanged

### Technical Features

Design	JIS F7399
Class	5K
Face-to-Face Design	JIS F7399
Inlet Design	Flanged (JIS B 2240)
Outlet Design	Flanged (JIS B 2240)
Operator	Handwheel

### Options

- Other materials, flange connections and nominal sizes on request

### Dimensions

DN	Length	PCD	Holes	Holes Dia	Weight
(MM)	(MM)	(MM)	(#)	(MM)	(kg)
15	65	60	4	12 (M10)	7
25	80	75	4	12 (M10)	8
40	100	95	4	15 (M12)	12

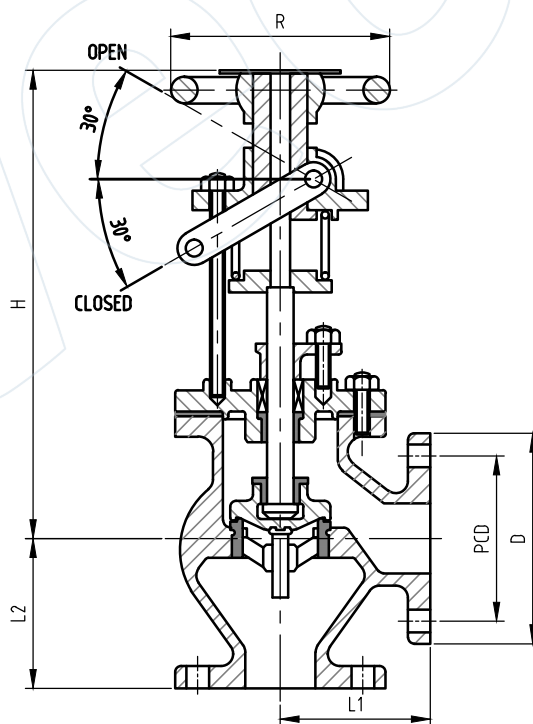

### Materials

Body / Bonnet	Bronze (JIS H 5111)
Stem	Brass (JIS H 3250)
Disc	Bronze (JIS H 5111)
Gasket	Graphite

All the product information presented on these pages is only indicative and is provided subject to typographical errors, changes and deviations. The buyer cannot derive any rights from this information. The seller excludes any liability for damage resulting from the use of this information.