

CHJ-DB-F1

DUO CHECK VALVE (F2237-5K)

Valveco®

Wafer pattern, nodular cast iron body, stainless steel stem, bronze disc, nbr rubber seat, 5k

Technical Features

Design	JIS F 2237-5K
Class	5K
Face-to-Face Design	JIS F 2237-5K
Inlet Design	Wafer
Outlet Design	Wafer

Options

- Other materials, flange connections and nominal sizes on request

Dimensions

DN	Length	OD	Weight
(MM)	(MM)	(MM)	(kg)
50	60	90	2
65	67	115	3
80	73	126	4
100	73	146	5
125	86	181	8
150	98	211	12
200	127	257	17
250	146	322	35
300	181	367	50
350	184	410	59
400	190	470	88
450	203	530	111
500	213	580	139

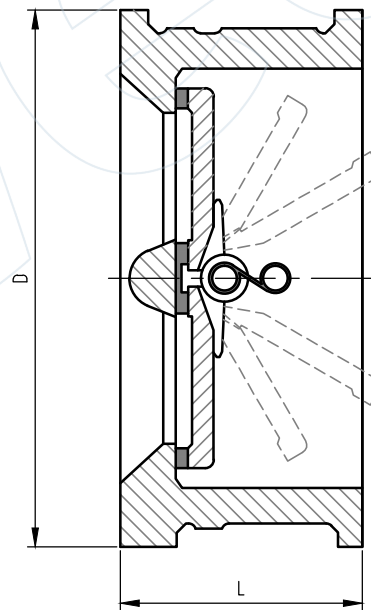

Materials

Body	Nodular Cast Iron (JIS G 5502)
Stem	Stainless Steel (AISI 304)
Disc	Bronze (JIS H 5111)
Seat Ring	NBR

All the product information presented on these pages is only indicative and is provided subject to typographical errors, changes and deviations. The buyer cannot derive any rights from this information. The seller excludes any liability for damage resulting from the use of this information.